

2.1-2.5 GHz InGaP HBT Matched Gain Block Amplifier

Features

- ✕ 41.0 dBm Output IP3 @ 2450 MHz
- ✕ 14.6 dB Gain @ 2140 MHz
- ✕ 13.2 dB Gain @ 2450 MHz
- ✕ 24.3 dBm P1dB @ 2450 MHz
- ✕ Low Performance Variation Over Temperature
- ✕ Low Cost: SOT-89 Package
- ✕ 100% DC On-Wafer Testing
- ✕ ESD Protection on All Die: >2000V HBM
- ✕ Low Thermal Resistance: <35°C/Watt
- ✕ Low Volt Supply: 5V, Active Bias

Applications

- ✕ PA Driver Amp, IF Amp, LO Buffer Amp
- ✕ UMTS, 3G, WLAN, WiMAX
- ✕ Wireless Broadband, Fixed Wireless, SATCOM
- ✕ Transmit and Receive Functions
- ✕ CATV

Description

The CGB7389-SC is a single stage, high power, high dynamic range, utility gain block amplifier. Designed for applications operating within the 2.1 to 2.5 GHz frequency range, Mimix's broadband, cascadable, gain block amplifier is an ideal solution for transmit, receive and IF applications.

This MMIC amplifier is available in an industry standard SOT-89 package. Mimix's InGaP HBT technology and an industry low thermal resistance offers a thermally robust and reliable gain block solution.

Functional Block Diagram (SOT-89)

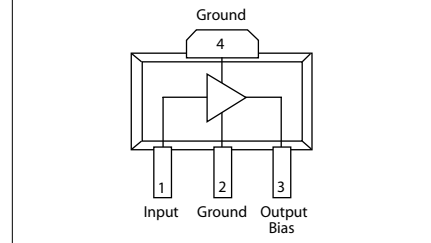

Absolute Maximum Ratings

Max Device Voltage	+6.0 V
Max Device Current	200 mA
Max Device Dissipated Power	1.2 W
RF Input Power	+17 dBm
Storage Temperature	-55°C to 150°C
Junction Temperature	150°C
Operating Temperature	-40°C to +85°C
Thermal Resistance	35° C/W
EDS (HBM)	2000 V

Operation of this device above any of these parameters may cause permanent damage.

The InGaP HBT die have extra pads to enable thorough DC testing. This unique test capability and the inclusion of ESD protection on all die, significantly enhances the quality, reliability and ruggedness of these products.

This gain block amplifier offers significant ease of use in a broad range of applications. The combination of high gain, P1dB and high OIP3 at low current makes the CGB7389-SC an ideal transmit and receive solution when used in applications including 3G, fixed wireless broadband, WLAN and WiMAX services operating from 2.1 to 2.5 GHz.

Electrical Characteristics (5V, Active Bias)

Unless otherwise specified, the following specifications are guaranteed at room temperature in a Mimix test fixture.

Parameter	Temperature (°C)	2140 MHz			2450 MHz			Units
		Min.	Typ.	Max.	Min.	Typ.	Max.	
Small Signal Gain	+25	13.3	14.3	15.3	12.0	13.0	14.0	dB
	-40 to +85	12.9	14.3	15.3	11.6	13.0	14.4	dB
Output P1dB	+25	22.0	23.0		22.5	23.5		dBm
	-40 to +85	21.8	23.0		22.3	23.5		dBm
Output IP3	+25	37.5	39.0		39.5	40.5		dBm
	-40 to +85	37.0	39.0		39.0	41.0		dBm
Noise Figure	+25		4.2	5.2		4.5	5.7	dB
	-40 to +85		4.2	5.7		4.5	6.2	dB
Operating Current	+25	105	115	125	105	115	125	mA
	-40 to +85	100	115	130	100	115	130	mA
Input Return Loss	+25	10	14		12	16		dB
	-40 to +85	9	14		11	16		dB
Output Return Loss	+25	16.0	24.0		12.0	16.0		dB
	-40 to +85	15.0	24.0		11.0	16.0		dB
Pout @ -45 dBc, ACP IS-95, 9 Forward Channels	+25		14.0			15.0		dBm
	-40 to +85		14.0			15.0		dBm

Notes: 1. Test Conditions in Mimix eval board, Vs = 5 V, Id = 115 mA Typ., Zs = Zl = 50Ω, OIP3 tone spacing = 1 MHz, Pout per tone = 11 dBm.
2. Values reflect performance in recommended application circuit.

2.1-2.5 GHz InGaP HBT Matched Gain Block Amplifier



July 2006 - Rev 26-Jul-06

CGB7389-SC
RoHS

Electrical Characteristics (5V, Active Bias)

Unless otherwise specified, the following specifications are guaranteed at room temperature in a Mimix test fixture.

Parameter	Temperature (°C)	2140 MHz			2450 MHz			Units
		Min.	Typ.	Max.	Min.	Typ.	Max.	
Small Signal Gain	+25	13.9	14.9	15.9	11.9	12.9	13.9	dB
	-40 to +85	13.5	14.9	16.3	11.5	12.9	14.3	dB
Output P1dB	+25	22.9	23.9		23.0	24.0		dBm
	-40 to +85	22.7	23.9		22.8	24.0		dBm
Output IP3	+25	39.5	41.0		39.5	41.0		dBm
	-40 to +85	38.5	41.0		39.5	41.0		dBm
Noise Figure	+25		4.3	5.3		5.0	6.0	dB
	-40 to +85		4.3	5.8		5.0	6.5	dB
Operating Current	+25	110	120	130	110	120	130	mA
	-40 to +85	105	120	135	105	120	135	mA
Input Return Loss	+25	10	13		13	17		dB
	-40 to +85	9	13		12	17		dB
Output Return Loss	+25	15.0	22.0		10.0	15.0		dB
	-40 to +85	14.0	22.0		9.0	15.0		dB
Pout @ -45 dBc, ACP IS-95, 9 Forward Channels	+25		16.0			15.0		dBm
	-40 to +85		16.0			15.0		dBm

Notes: 1. Test Conditions in Mimix eval board, $V_s = 8\text{ V}$, $I_d = 120\text{ mA Typ.}$, $R_{bias} = 27\Omega$, $Z_s = Z_l = 50\Omega$, OIP3 tone spacing = 1 MHz, Pout per tone = 11 dBm.
2. Values reflect performance in recommended application circuit.

2.1-2.5 GHz InGaP HBT Matched Gain Block Amplifier



July 2006 - Rev 26-Jul-06

CGB7389-SC
RoHS

Typical S-Parameter and Noise Performance: 2140 MHz, 5V (Matched for 2.1-2.5 GHz Operation)

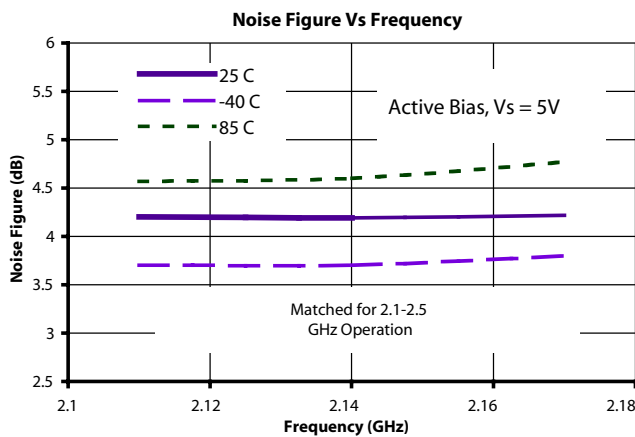
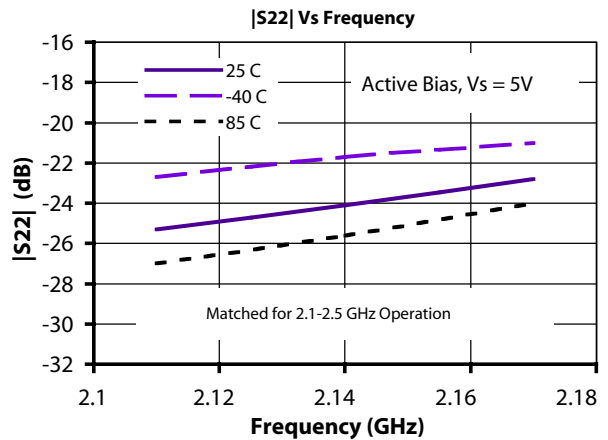
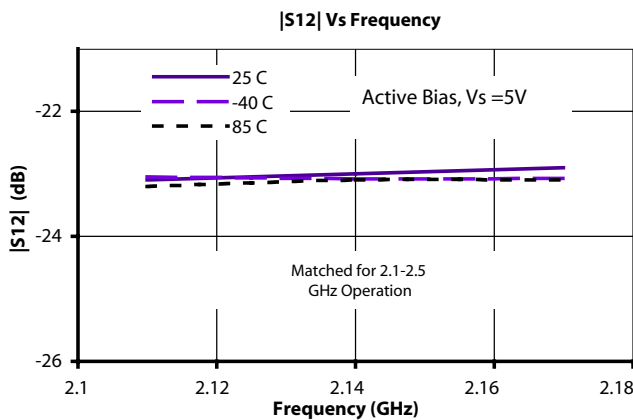
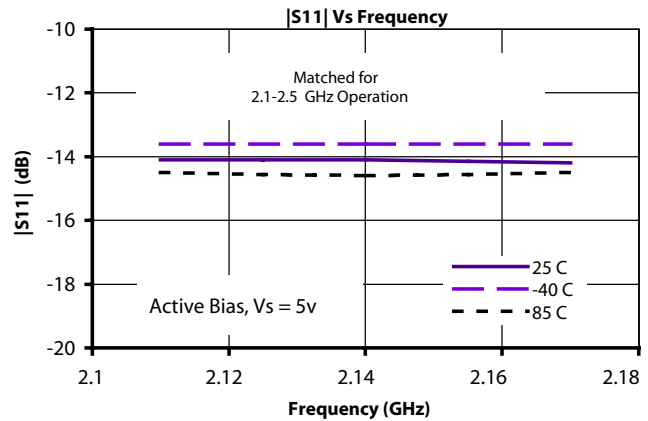
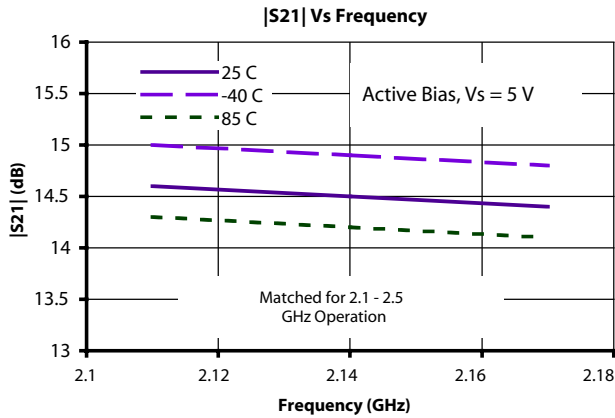

2.1-2.5 GHz InGaP HBT Matched Gain Block Amplifier



July 2006 - Rev 26-Jul-06

CGB7389-SC
RoHS

Typical S-Parameter and Noise Performance: 2140 MHz, 5V (Matched for 2.1-2.5 GHz Operation)

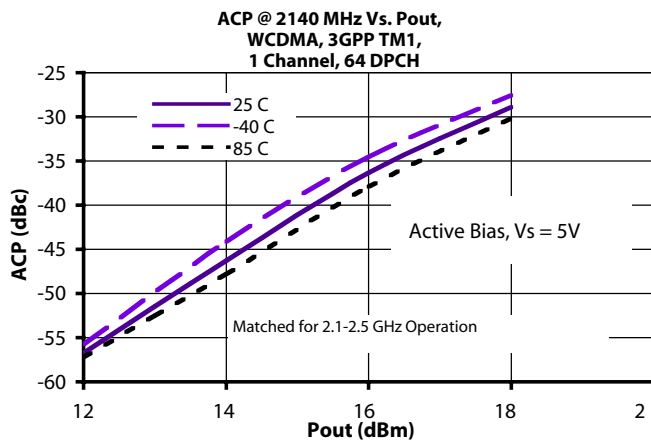
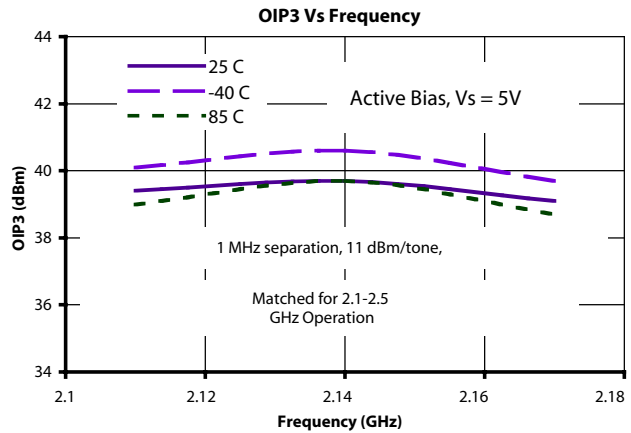
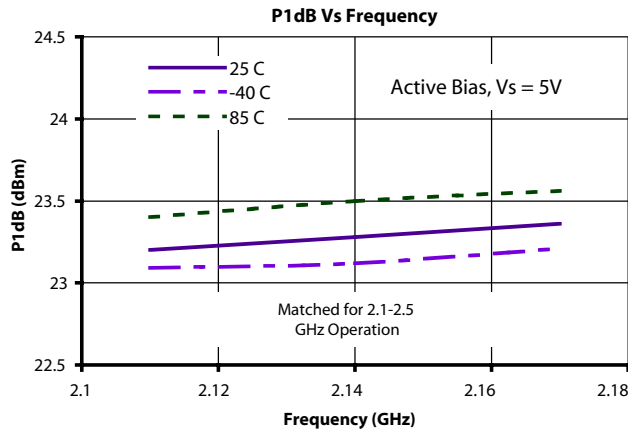

2.1-2.5 GHz InGaP HBT Matched Gain Block Amplifier



July 2006 - Rev 26-Jul-06

CGB7389-SC
RoHS

Typical S-Parameter and Noise Performance: 2450 MHz, 5V (Matched for 2.1-2.5 GHz Operation)

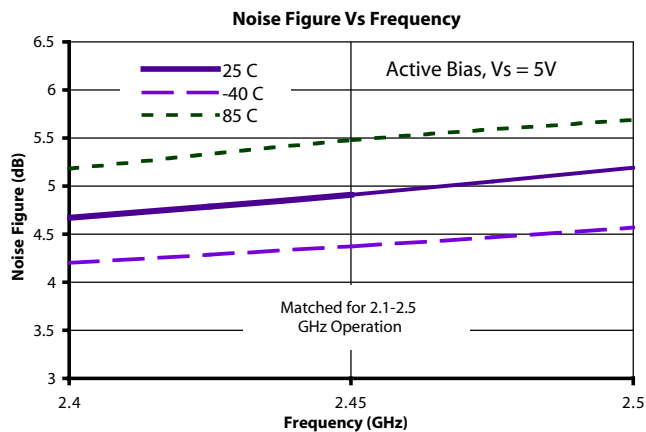
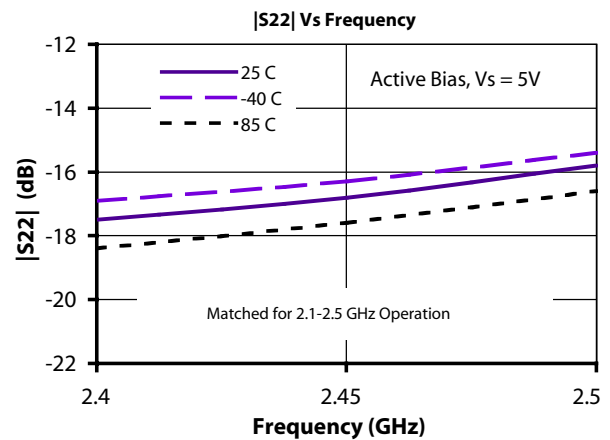
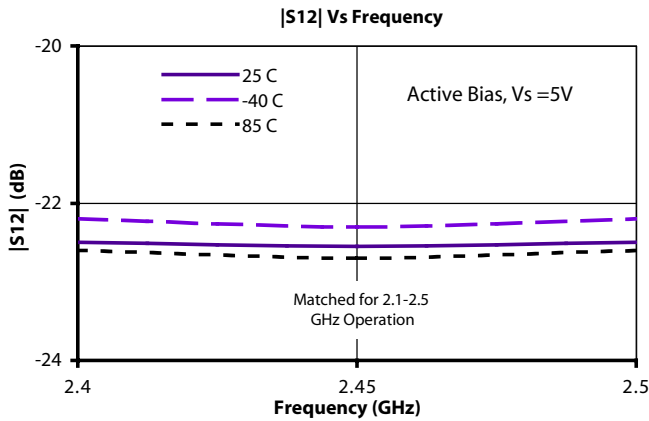
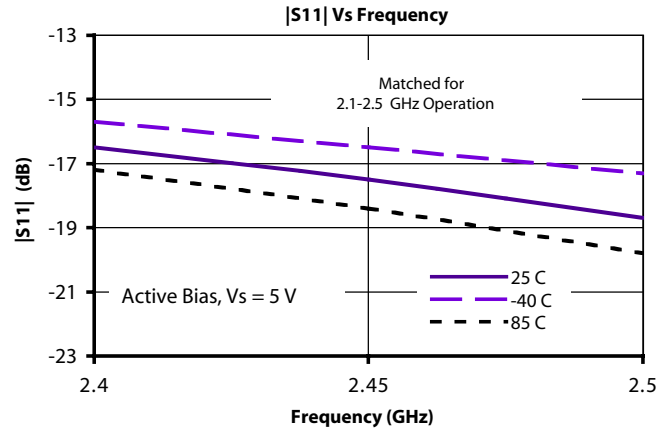
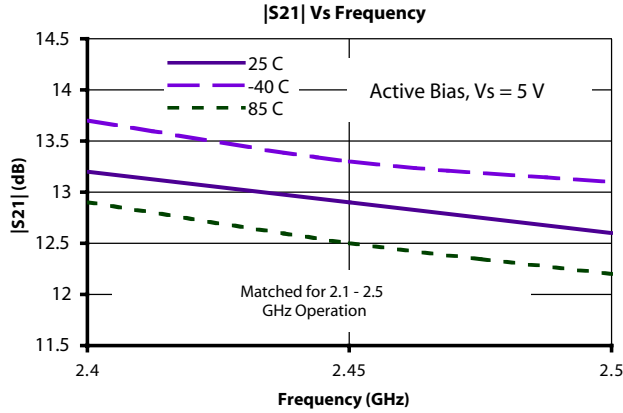

2.1-2.5 GHz InGaP HBT Matched Gain Block Amplifier



July 2006 - Rev 26-Jul-06

CGB7389-SC
RoHS

Typical S-Parameter and Noise Performance: 2450 MHz, 5V (Matched for 2.1-2.5 GHz Operation)

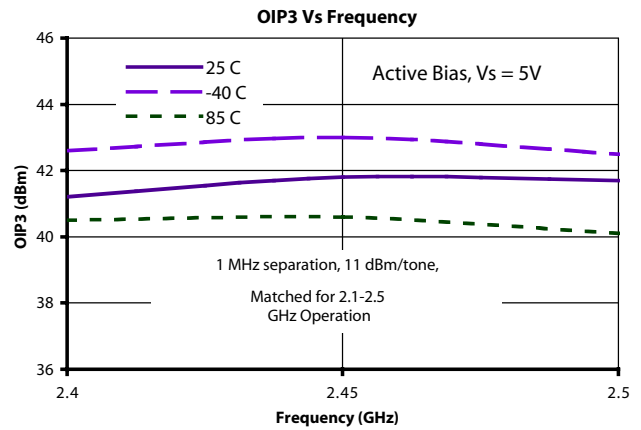
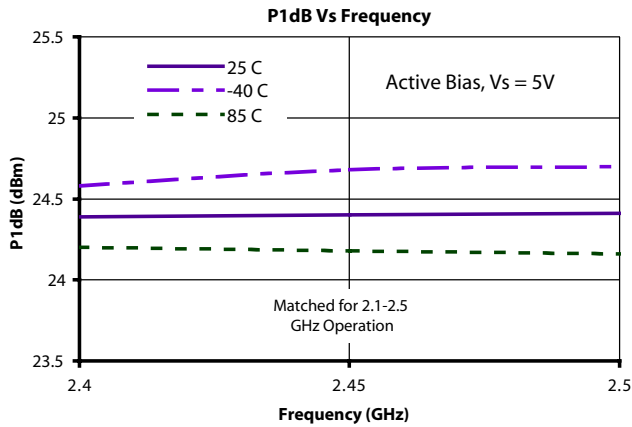

2.1-2.5 GHz InGaP HBT Matched Gain Block Amplifier



July 2006 - Rev 26-Jul-06

CGB7389-SC
RoHS

Typical S-Parameter and Noise Performance: 2140 MHz, 8V (Matched for 2.1-2.5 GHz Operation)

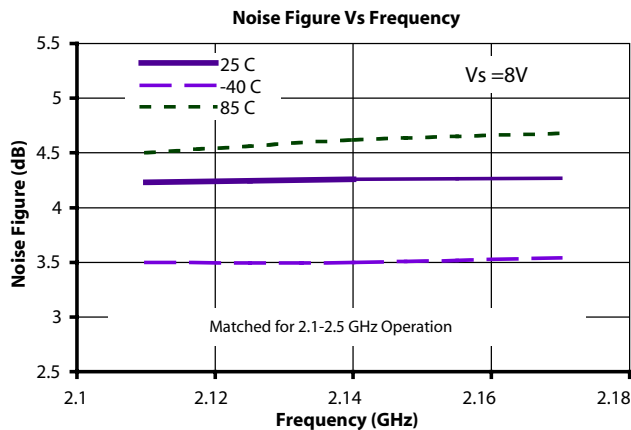
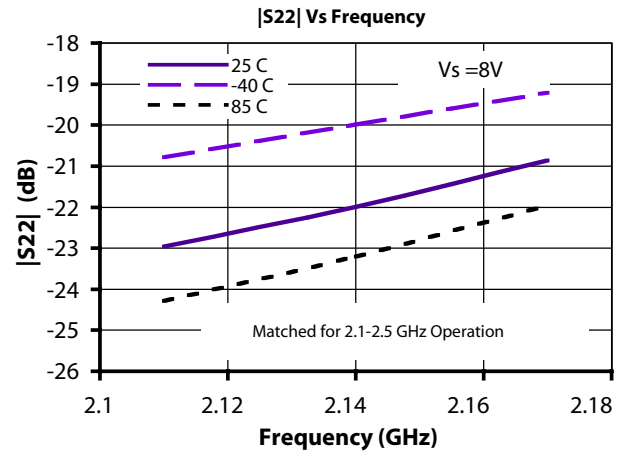
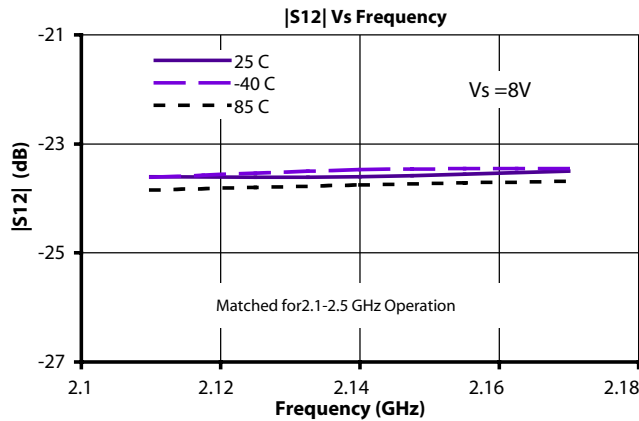
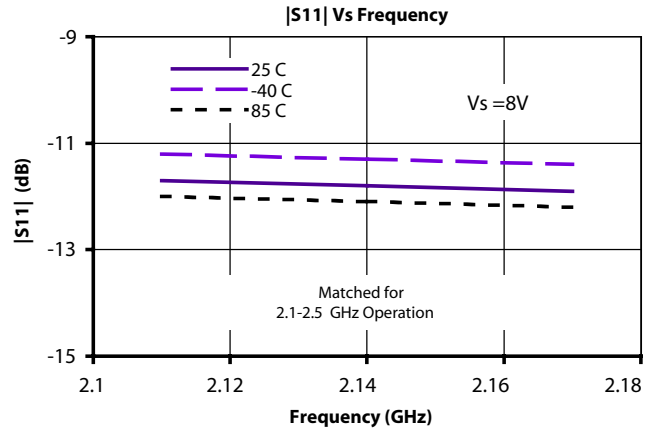
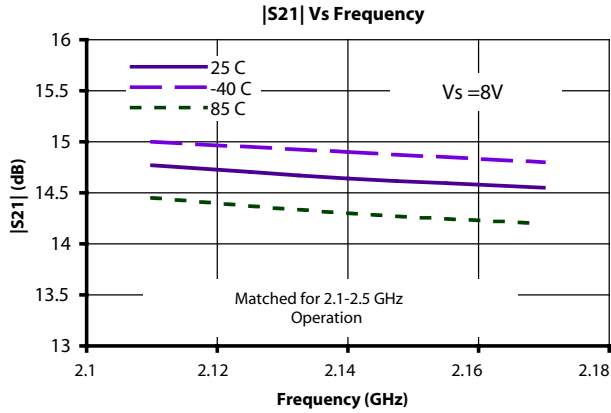

2.1-2.5 GHz InGaP HBT Matched Gain Block Amplifier



July 2006 - Rev 26-Jul-06

CGB7389-SC
RoHS

Typical S-Parameter and Noise Performance: 2140 MHz, 8V (Matched for 2.1-2.5 GHz Operation)

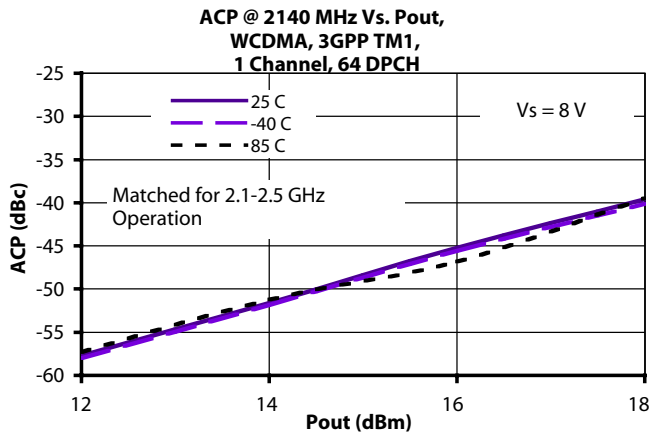
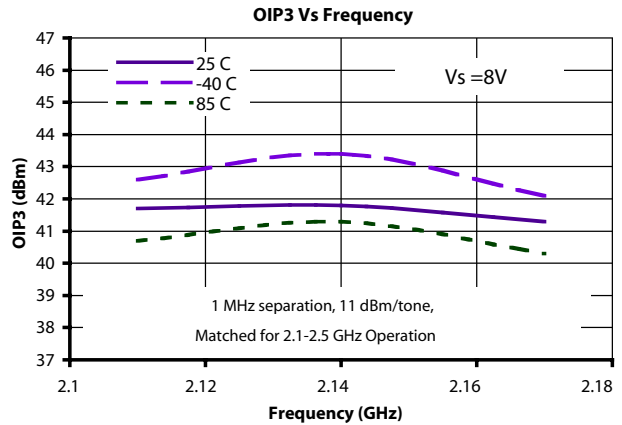
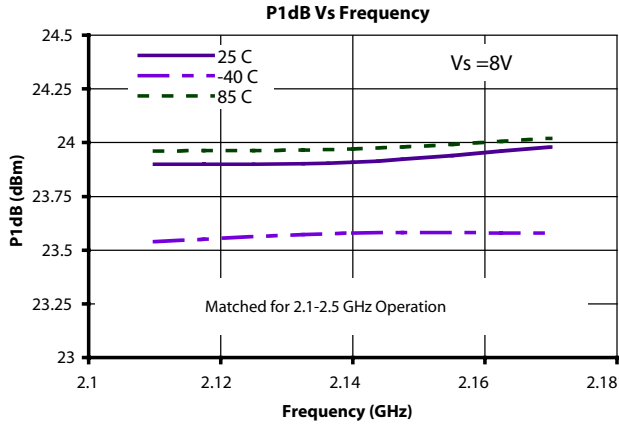

2.1-2.5 GHz InGaP HBT Matched Gain Block Amplifier



July 2006 - Rev 26-Jul-06

CGB7389-SC
RoHS

Typical S-Parameter and Noise Performance: 2450 MHz, 8V (Matched for 2.1-2.5 GHz Operation)

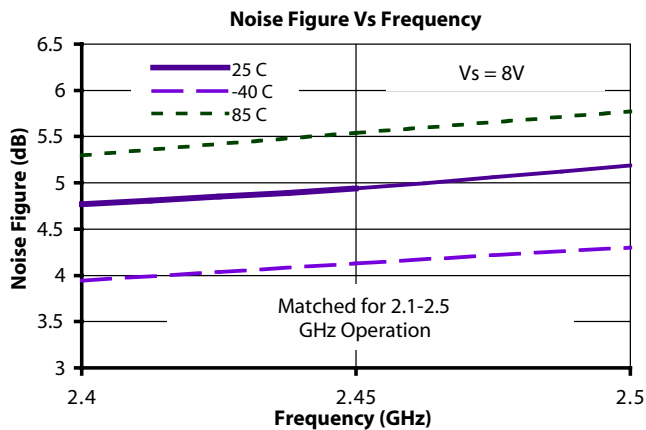
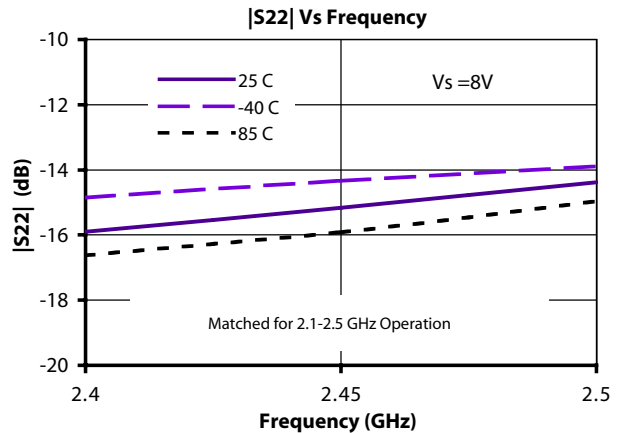
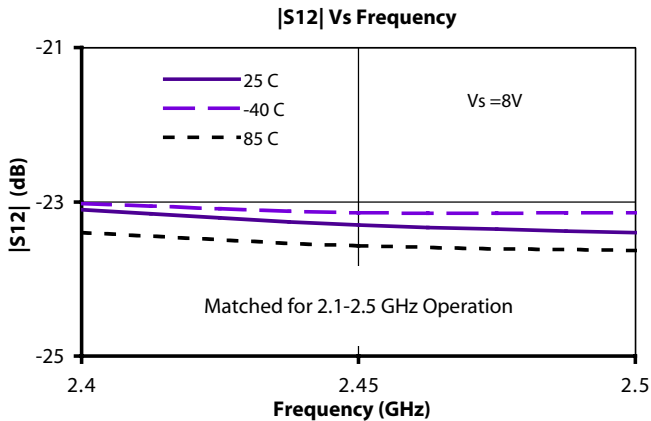
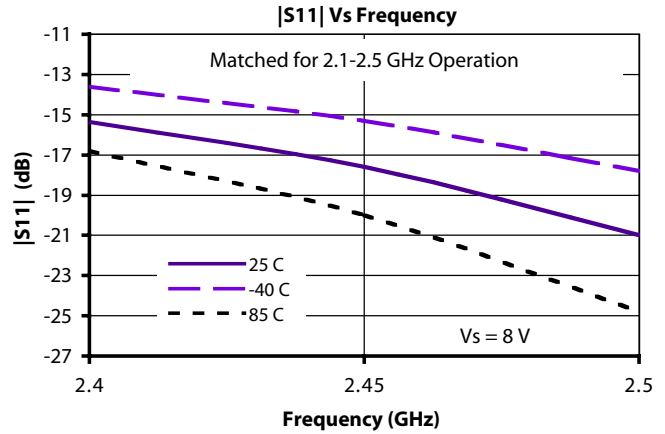
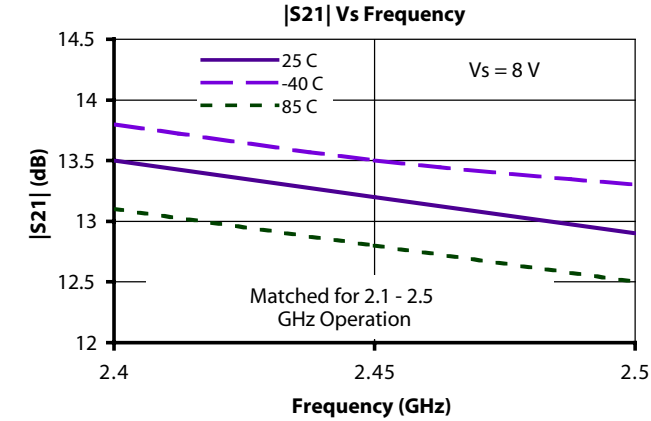

2.1-2.5 GHz InGaP HBT Matched Gain Block Amplifier



July 2006 - Rev 26-Jul-06

CGB7389-SC
RoHS

Typical S-Parameter and Noise Performance: 2450 MHz, 8V (Matched for 2.1-2.5 GHz Operation)

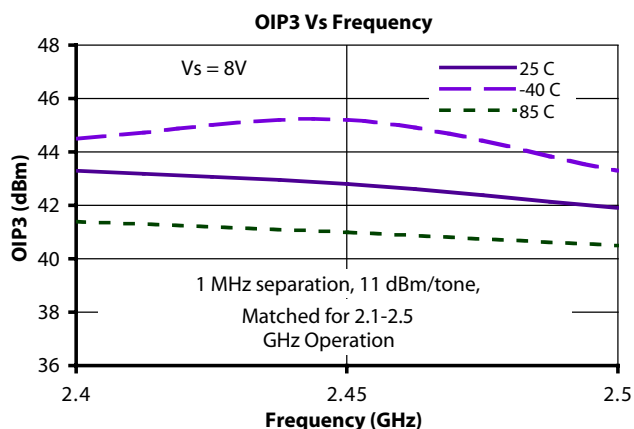
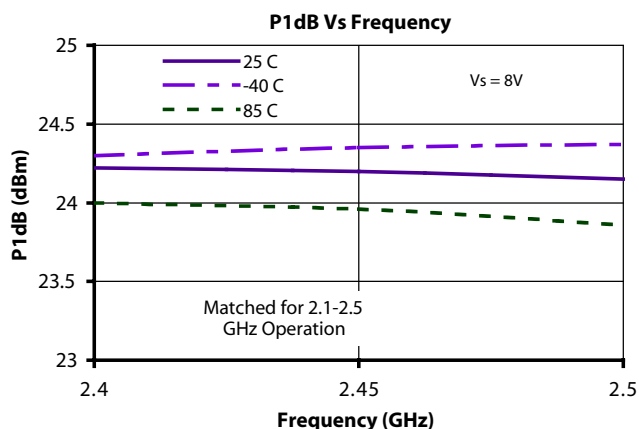

2.1-2.5 GHz InGaP HBT Matched Gain Block Amplifier



July 2006 - Rev 26-Jul-06

CGB7389-SC
RoHS

Typical Scattering Parameters (Vd = +5.3V, Icc = 110 mA, T = 23°C, device in a 50 ohm system)

Frequency (MHz)	S ₁₁		S ₂₁		S ₁₂		S ₂₂	
	(Mag)	(Ang)	(Mag)	(Ang)	(Mag)	(Ang)	(Mag)	(Ang)
100	0.53	-172	25.66	151.90	0.015	10	0.19	-122
200	0.62	-174	21.16	130.30	0.018	12	0.31	-141
300	0.68	-180	17.18	114.40	0.019	11	0.37	-155
400	0.71	174	14.21	102.30	0.020	10	0.40	-165
500	0.73	169	12.03	92.47	0.022	8	0.42	-174
600	0.73	163	10.44	84.07	0.023	7	0.43	180
700	0.74	158	9.26	76.51	0.024	6	0.43	173
800	0.74	153	8.32	69.35	0.025	4	0.43	168
900	0.73	148	7.60	62.76	0.027	2	0.42	163
1000	0.73	143	7.04	56.14	0.028	1	0.41	158
1100	0.72	138	6.59	49.73	0.030	-2	0.41	153
1200	0.71	132	6.22	43.19	0.032	-5	0.39	149
1300	0.69	127	5.95	36.60	0.034	-8	0.38	144
1400	0.67	122	5.73	29.62	0.037	-11	0.36	140
1500	0.65	116	5.55	22.41	0.040	-15	0.34	137
1600	0.62	110	5.42	14.88	0.043	-21	0.32	134
1700	0.58	105	5.33	6.71	0.047	-26	0.29	132
1800	0.53	99	5.26	-2.36	0.051	-33	0.27	132
1900	0.46	93	5.18	-12.42	0.056	-41	0.24	135
2000	0.38	90	5.09	-23.33	0.060	-50	0.22	143
2100	0.29	91	4.97	-35.62	0.064	-61	0.23	154
2200	0.22	107	4.74	-49.35	0.067	-73	0.27	161
2300	0.23	135	4.38	-64.03	0.068	-86	0.34	163
2400	0.33	148	3.90	-78.90	0.067	-100	0.42	158
2500	0.46	146	3.34	-93.37	0.063	-114	0.49	150
2600	0.57	139	2.76	-106.90	0.057	-127	0.54	142
2700	0.66	131	2.22	-119.10	0.051	-139	0.58	133
2800	0.73	123	1.75	-129.70	0.045	-150	0.60	125
2900	0.78	115	1.36	-138.90	0.040	-160	0.61	117
3000	0.82	107	1.05	-146.90	0.035	-170	0.61	109
3100	0.84	100	0.79	-153.70	0.030	-179	0.61	103
3200	0.87	93	0.58	-159.20	0.027	172	0.61	96
3300	0.88	87	0.41	-162.90	0.023	163	0.61	90
3400	0.89	81	0.28	-163.90	0.021	153	0.61	84
3500	0.90	75	0.18	-159.50	0.019	144	0.61	78
3600	0.91	69	0.10	-141.00	0.017	135	0.61	72
3700	0.92	64	0.08	-101.30	0.015	124	0.60	67
3800	0.92	59	0.11	-73.87	0.014	114	0.60	61
3900	0.93	53	0.15	-64.97	0.014	102	0.60	56
4000	0.93	48	0.19	-63.40	0.013	92	0.60	51
4100	0.93	43	0.22	-64.81	0.013	82	0.60	46
4200	0.93	38	0.24	-67.51	0.012	71	0.60	41
4300	0.94	33	0.26	-70.99	0.013	62	0.60	36
4400	0.94	28	0.28	-74.91	0.013	53	0.60	31
4500	0.94	23	0.29	-79.11	0.013	45	0.60	26
4600	0.94	19	0.30	-83.52	0.014	38	0.61	21
4700	0.94	14	0.30	-87.90	0.014	30	0.61	16
4800	0.94	9	0.31	-92.38	0.015	24	0.61	11
4900	0.94	5	0.31	-96.88	0.015	18	0.61	7
5000	0.94	0	0.31	-101.40	0.015	13	0.62	2

Continues Next Page. S-Parameter Data Files are available on-line at: www.mimixbroadband.com

Mimix Broadband, Inc., 10795 Rockley Rd., Houston, Texas 77099
Tel: 281.988.4600 Fax: 281.988.4615 mimixbroadband.com

Page 11 of 15

Characteristic Data and Specifications are subject to change without notice. ©2006 Mimix Broadband, Inc.
Export of this item may require appropriate export licensing from the U.S. Government. In purchasing these parts, U.S. Domestic customers accept their obligation to be compliant with U.S. Export Laws.

2.1-2.5 GHz InGaP HBT Matched Gain Block Amplifier



July 2006 - Rev 26-Jul-06

CGB7389-SC
RoHS

Typical Scattering Parameters (Vd = +5.3V, Icc = 110 mA, T = 23°C, device in a 50 ohm system)

Frequency (MHz)	S ₁₁		S ₂₁		S ₁₂		S ₂₂	
	(Mag)	(Ang)	(Mag)	(Ang)	(Mag)	(Ang)	(Mag)	(Ang)
5100	0.94	-4	0.31	-105.80	0.016	8	0.62	-2
5200	0.94	-8	0.30	-110.20	0.016	3	0.63	-7
5300	0.94	-12	0.30	-114.60	0.016	-1	0.63	-11
5400	0.94	-17	0.30	-119.00	0.017	-6	0.64	-16
5500	0.94	-21	0.29	-123.40	0.017	-10	0.64	-20
5600	0.93	-25	0.28	-127.80	0.018	-13	0.65	-24
5700	0.93	-29	0.28	-131.90	0.018	-17	0.65	-28
5800	0.93	-32	0.27	-136.10	0.018	-20	0.66	-32
5900	0.93	-36	0.26	-140.20	0.018	-23	0.66	-36
6000	0.93	-40	0.25	-144.30	0.019	-27	0.67	-40
6100	0.93	-44	0.25	-148.40	0.019	-30	0.68	-44
6200	0.92	-47	0.24	-152.30	0.019	-33	0.68	-47
6300	0.92	-51	0.23	-156.10	0.019	-36	0.69	-51
6400	0.92	-54	0.22	-160.00	0.020	-39	0.69	-54
6500	0.92	-57	0.22	-163.80	0.020	-41	0.70	-58
6600	0.92	-61	0.21	-167.60	0.020	-44	0.71	-61
6700	0.92	-64	0.20	-171.30	0.020	-46	0.71	-65
6800	0.91	-67	0.19	-174.80	0.021	-48	0.72	-68
6900	0.91	-70	0.19	-178.40	0.021	-51	0.72	-71
7000	0.91	-73	0.18	-178.00	0.021	-53	0.73	-74
7100	0.91	-76	0.17	-174.70	0.021	-56	0.73	-77
7200	0.91	-79	0.16	-171.30	0.021	-57	0.74	-80
7300	0.91	-82	0.16	-168.00	0.022	-60	0.74	-83
7400	0.91	-85	0.15	-164.70	0.022	-62	0.75	-86
7500	0.90	-87	0.15	-161.40	0.022	-64	0.75	-89
7600	0.90	-90	0.14	-158.20	0.022	-66	0.76	-92
7700	0.90	-93	0.13	-155.00	0.022	-68	0.76	-94
7800	0.90	-95	0.13	-152.00	0.023	-70	0.76	-97
7900	0.90	-98	0.12	-148.90	0.023	-73	0.77	-100
8000	0.89	-100	0.12	-146.00	0.023	-74	0.77	-102
8100	0.89	-103	0.11	-143.00	0.023	-76	0.77	-105
8200	0.89	-105	0.11	-140.60	0.023	-78	0.78	-108
8300	0.89	-108	0.10	-137.10	0.024	-80	0.78	-110
8400	0.89	-110	0.10	-134.20	0.024	-82	0.78	-112
8500	0.89	-112	0.10	-131.30	0.024	-83	0.79	-115
8600	0.89	-115	0.09	-128.40	0.025	-85	0.79	-117
8700	0.89	-117	0.09	-125.50	0.024	-87	0.79	-120
8800	0.88	-119	0.09	-122.80	0.025	-89	0.79	-122
8900	0.88	-121	0.08	-120.10	0.025	-90	0.80	-124
9000	0.88	-123	0.08	-117.30	0.026	-93	0.80	-127
9100	0.88	-125	0.08	-114.50	0.026	-94	0.80	-129
9200	0.88	-128	0.07	-111.90	0.026	-96	0.80	-131
9300	0.88	-130	0.07	-109.10	0.027	-98	0.80	-133
9400	0.88	-132	0.07	-106.50	0.027	-100	0.80	-136
9500	0.88	-134	0.06	-103.90	0.027	-101	0.80	-138
9600	0.87	-136	0.06	-101.00	0.028	-104	0.80	-140
9700	0.87	-138	0.06	-98.29	0.028	-105	0.80	-142
9800	0.87	-140	0.06	-95.85	0.028	-107	0.80	-144
9900	0.87	-142	0.05	-93.27	0.029	-109	0.80	-146
10000	0.87	-144	0.05	-90.45	0.030	-111	0.80	-149

S-Parameter Data Files are available on-line at: www.mimixbroadband.com

Mimix Broadband, Inc., 10795 Rockley Rd., Houston, Texas 77099
Tel: 281.988.4600 Fax: 281.988.4615 mimixbroadband.com

Page 12 of 15

Characteristic Data and Specifications are subject to change without notice. ©2006 Mimix Broadband, Inc.
Export of this item may require appropriate export licensing from the U.S. Government. In purchasing these parts, U.S. Domestic customers accept their obligation to be compliant with U.S. Export Laws.

2.1-2.5 GHz InGaP HBT Matched Gain Block Amplifier

July 2006 - Rev 26-Jul-06

Application Circuit - Active Bias, V Supply = 5V

Note: This schematic represents the topology of the application circuit recommended by Mimix.

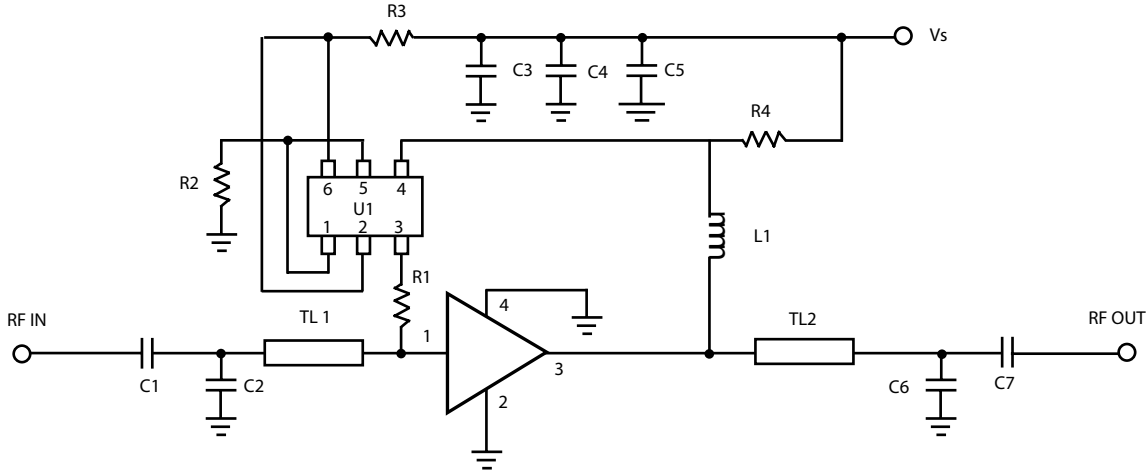

Ref Designator	2140 MHz Value	2450 MHz Value	Description / Size
C1, C7	68 pF	68 pF	PHYC 0805 NPO
C2	1.0 pF	1.0 pF	PHYC 0805 10%
C3	0.1 μF	0.1 μF	VITR 0.1 μF 0603 X7R
C4	1000 pF	1000 pF	PHYC 0805 NPO
C5	22 pF	22 pF	PHYC 0805 NPO
C6	1.0 pF	1.0 pF	PHYC 0603 NPO
L1	22 nH	22 nH	TOKO 0603 10%
R1	750 Ω	750 Ω	KOA 0805 5% 1/8W
R2	1.8K Ω	1.8K Ω	KOA 0603 1% 1/16W
R3	220 Ω	220 Ω	KOA 0805 1% 1/8W
R4	4.3 Ω	4.3 Ω	KOA 0805 1% 1/8W
U1	UMZ1N	UMZ1N	KOA 0805 1% 1/8W
TL1	9 deg	10 deg	
TL2	14 deg	16 deg	

Active Bias Evaluation Board Layout

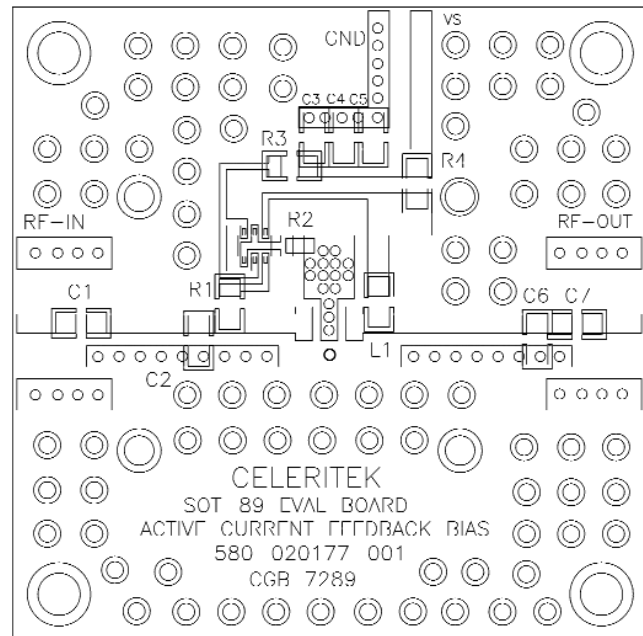

2.1-2.5 GHz InGaP HBT Matched Gain Block Amplifier

July 2006 - Rev 26-Jul-06

Application Circuit - Passive Bias, V Supply = 8V

Note: This schematic represents the topology of the application circuit recommended by Mimix.

Recommended Bias Resistor Values for ID = 120 mA					
Supply Voltage (V)	7V	8V	9V	10V	12V
Rbias (R1 Description: 1206 1/4W 1%)	18Ω	27Ω	—	—	—
Rbias (R1 Description: 1210 1/2W 1%)	—	—	36Ω	43Ω	62Ω

Note: Rbias provides DC bias stability over temperature.

Application Schematic

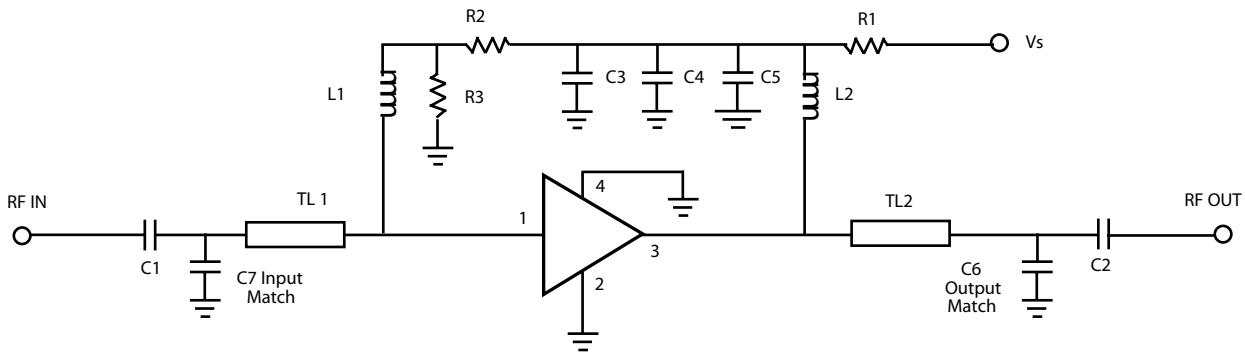

Ref Designator	2140 MHz Value	2450 MHz Value	Description / Size
C1, C2	1000 pF	1000 pF	PHYC 0805 NPO
C3	DNP	DNP	0805 X7R
C4	DNP	DNP	—
C5	1 μF	1 μF	—
C6	1.0 pF	1.0 pF	PHYC 0805 NPO 10%
C7	1.0 pF	1.0 pF	PHYC 0805 NPO 10%
L1	22 nH	22 nH	Coilcraft 0603 10%
L2	22 nH	22 nH	Coilcraft 0603 10%
R1	27Ω	27Ω	KOA 2010 5% 3/4W
R2	391Ω	391Ω	KOA 0805 1% 1/8W
R3	182Ω	182Ω	KOA 0805 1% 1/8W
EL1	9 deg	10 deg	—
EL2	21 deg	45 deg	—

Passive Bias Evaluation Board Layout

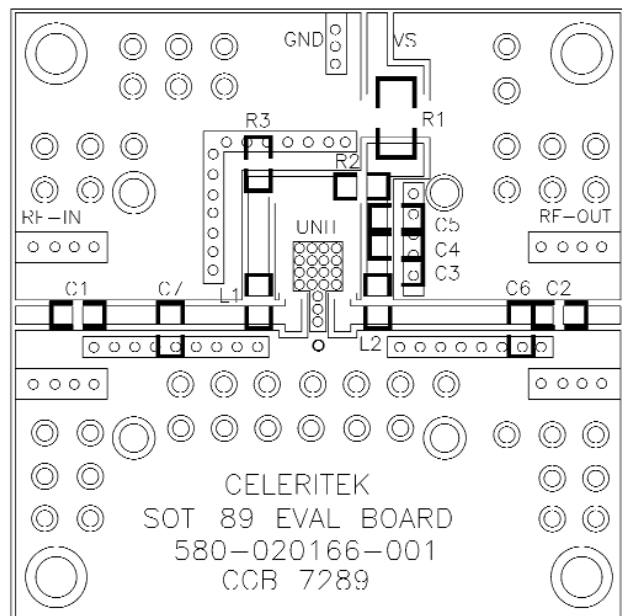

2.1-2.5 GHz InGaP HBT Matched Gain Block Amplifier

Physical Dimensions - SC Package (SOT-89)

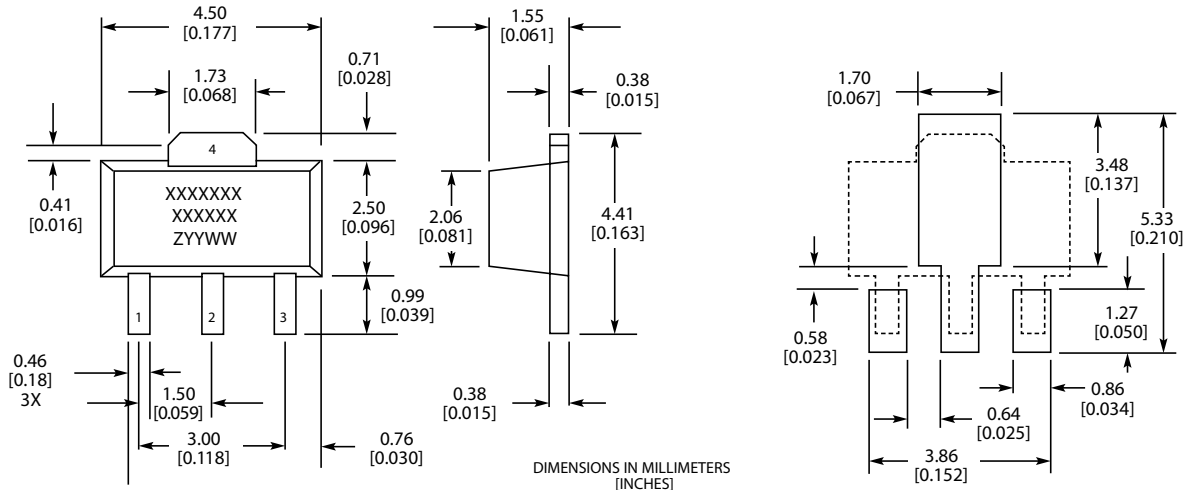

MARKINGS:
 XXXXXXX = MIMIX MODEL NO.
 XXXXXX = WAFER LOT NO.
 ZYYWW = DATE CODE (YR/WEEK)
 FIRST LETTER COUNTRY OF ORIGIN IF OTHER THAN USA



Caution: ESD Sensitive
 Appropriate precautions in handling, packaging
 and testing devices must be observed.

Ordering Information

Part Number for Ordering

CGB7389-BD
 CGB7389-SC-0G00
 CGB7389-SC-0G0T
 CGB7389-SP-0G00
 CGB7389-SP-0G0T
 PB-CGB7389-SC-0000
 PB-CGB7389-SP-0000

Description

Bare die in GelPak
 Matte Tin plated RoHS compliant SOT-89 surface mount package in bulk quantity
 Matte Tin plated RoHS compliant SOT-89 surface mount package in tape and reel
 Matte Tin plated RoHS compliant SOT-86 surface mount package in bulk quantity
 Matte Tin plated RoHS compliant SOT-86 surface mount package in tape and reel
 Evaluation Board for SOT-89 packaged device with SMA connectors
 Evaluation Board for SOT-86 packaged device with SMA connectors

We also offer the plastic packages with SnPb (Tin-Lead) or NiPdAu plating. Please contact your regional sales manager for more information regarding different plating types